



snowshovels.eu

FORM
PLASTIC





100%
satisfaction



Magnum



freeze resist



de-ice



long life



ergo design



alu-airy



alu-edge



steel-edge



anti scratch



multi purpose



water resist



click style



sport & travel



super power



stay warm



recycling



telescopic option

**Nasze produkty
obecne
w całej Europie**

Global reach





Firma została powołana do życia ponad 40 lat temu. Przez tak długi czas wypracowaliśmy metody umożliwiające dostarczanie klientom najlepszych rozwiązań produktowych i usługowych.

Oferta zawiera ponad 300 produktów sklasyfikowanych w kilkunastu grupach produktowych. Ze względu na swoją silną i dobrze zorganizowaną sieć dystrybucyjną, FORM-PLASTIC jest w stanie dotrzeć do każdego polskiego domu. Nasze starannie dopracowane wzornictwo i jakość są doceniane tak przez klientów polskich jak i we wszystkich krajach, do których eksportujemy. Do produktów firmy zalicza się: plastikowe doniczki, wazon, flakony, gazony, skrzynki balkonowe, płotki dekoracyjne, miski, konewki i wiele innych.

Jesteśmy szczególnie dumni z nowych linii łopat do odśnieżania, a także innych produktów zimowych, które dedykujemy na rynek światowy. Każdy znajdzie coś odpowiedniego dla siebie. Lekkość, a jednocześnie stabilna konstrukcja zapewniają długie życie naszym produktom i odporność w nawet ekstremalnych warunkach. Gwarantujemy doskonałe wykończenie i wyważenie artykułów co wraz z nowoczesnym designem i zastosowaniem najmodniejszych na rynku kolorów przyczynia się do podwyższenia standardów w grupie zimowych artykułów pierwszej potrzeby.

Jakość produktów jest potwierdzona kartami technologicznymi materiałów, z których wykonywane są nasze artykuły – użycie surowca o najwyższych parametrach jakościowych stanowi dla nas wysoki priorytet i w takim działaniu upatrujemy sens naszej działalności.

FORM-PLASTIC inwestuje swój czas, energię i pieniądze nie tylko w maszyny, technologie i powiększanie powierzchni do magazynowania, ale głównie w ludzi. Nasz zespół jest ciągle doszkalany w zakresie know-how oraz stanowi pomoc i wsparcie dla klientów w dokonywaniu przez nich wyborów – nie tylko zakupowych.

Utrzymujemy dobrą jakość wyrobów jednocześnie dochowując możliwie jak najkrótszych terminów. Jednak aby najlepiej się przekonać o atutach firmy, zapraszamy do bezpośredniego kontaktu. Nasi specjaliści są do Państwa dyspozycji.

FORM-PLASTIC Sp. z o.o.

Polska

87-720 Ciechocinek, ul. Bema 146

tel.: +48 54 283 62 63

fax: +48 54 283 22 77

www.snowshovels.eu

www.formplastic.pl

biuro@formplastic.pl

office@formplastic.pl





The company was brought into existence over 40 years ago. During all the years it has worked out the best methods how to provide both the best products and service.

The offer includes over 300 products classified in several product groups. Thanks to its strong and well-organized distribution system, FORM-PLASTIC is capable of reaching every single house in Poland. Thoroughly refined designs of our products are highly appreciated by customers in Poland and in all the countries we export to. Our product range includes: plastic flowerpots, vases, urns, balcony boxes, decorative fences, bowls, watering cans, water sprinklers and many others.

We take pride in our modernized product line of snow shovels and other winter accessories that have been designed to satisfy very every customer around the world. Everyone will find something appropriate for them. Lightness and, on the other hand, stable construction guarantee products' long life and high resistance in extreme conditions. We assure great balance and finishing which together with both modern design & use of the most trendy colours constitute the reason to higher the standards of winter accessories.

The quality of all products is verified and certified by the materials we use which according to our policy and philosophy should be and are of high importance.

FORM-PLASTIC invests time, energy and money not only in the machines, technologies and increasing the storing area but also – perhaps even mainly - in the staff - who is constantly being taught how to provide the best know-how and how to assist in all customer's choices.

We maintain good kind of the goods simultaneously keeping short terms.
The best way to verify all these statements is to try us out. You are welcome to contact us at any time.
Our specialists are here to help you.





Euro Solid



Dostępne w dwóch uniwersalnych rozmiarach. Znajdują zastosowanie w trudnych warunkach atmosferycznych. Są masywne, a jednocześnie stosunkowo lekkie co ogranicza zużycie energii. Aluminiowe okucie zwiększa wytrzymałość łopaty i zapobiega ścieraniu się powierzchni.

Aluminiowy trzonek to połączenie funkcjonalności, nowoczesności i lekkości.

Aluminium shaft – combination of functionality, novelty and lightness.



Euro Solid 40 Alu

Kolory: ●

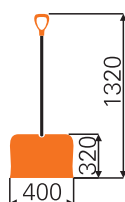

Nº 2000

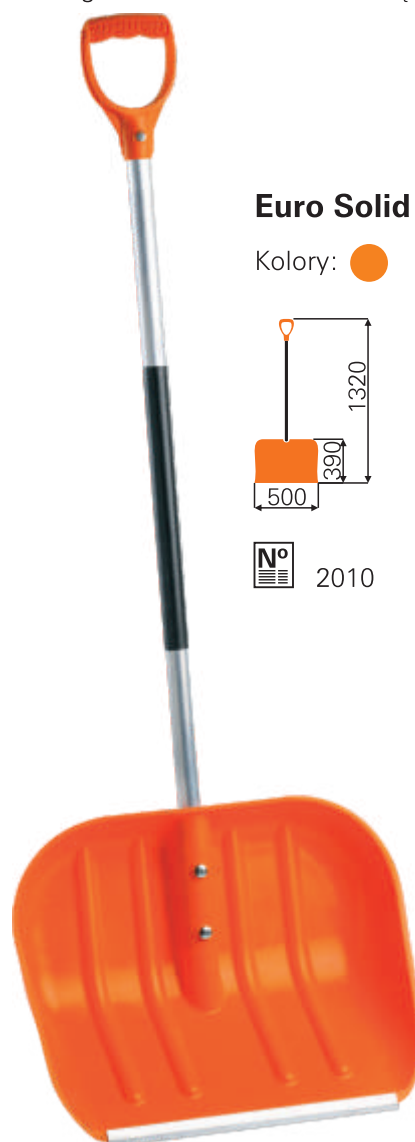

Euro Solid 50 Alu

Kolory: ●

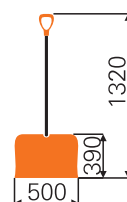

Nº 2010



Available in two universal sizes. It is this kind of shovel that can be used in harsh weather conditions where its massive yet light construction enables us to save energy that can be used for other purposes. Aluminium blade contributes to increasing shovel's durability and simultaneously prevents the surface from being scratched.

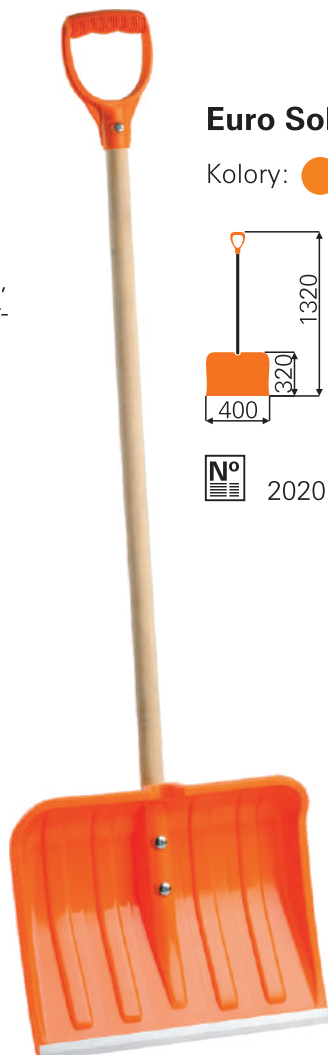

Euro Solid 40 Wood

Kolory: ●

Drewniany trzonek gwarantuje stabilność, jednocześnie jest przyjazny dla środowiska.

Wooden shaft guarantees stability and is eco-friendly at the same time.

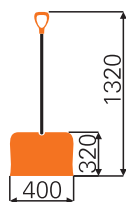

N° 2020

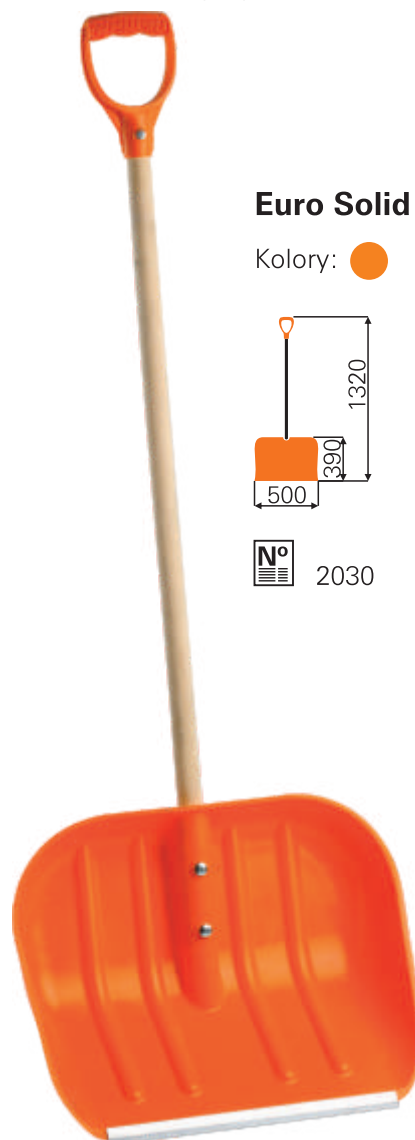

Euro Solid 50 Wood

Kolory: ●

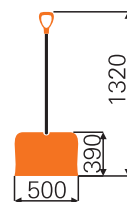

N° 2030



Classic



Bogata kolorystyka i świeży design łopaty sprawiają, że nawet zima staje się przyjemniejsza. Trwałość tworzywa plus wykorzystanie silnego aluminiowego okucia to gwarancja zadowolenia klientów.

Aluminiowy trzonek to połączenie funkcjonalności, nowoczesności i lekkości.

Rich colour availability and fresh design make winter more cozy.

Durability of the material together with the massive aluminium blade guarantee customers' satisfaction.

Aluminium shaft – combination of functionality, novelty and lightness.



Classic 40 Alu

Kolory:

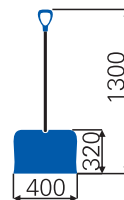

N° 2040



opcjonalnie składanie łopaty na klips
telescopic shaft option



Classic 46 Alu

Kolory: ● ● ● ● ●

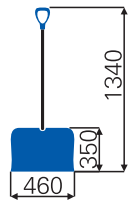

N° 2050

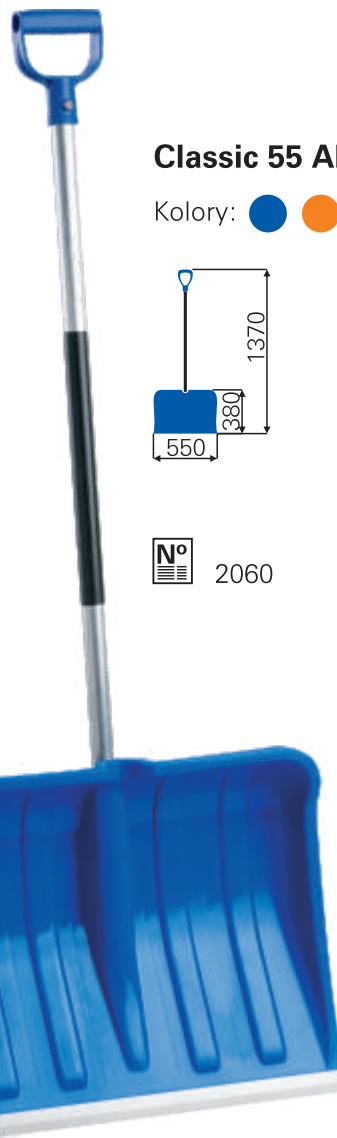

Classic 55 Alu

Kolory: ● ● ● ● ●

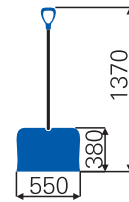

N° 2060



Classic



Bogata kolorystyka i świeży design łopaty sprawiają, że nawet zima staje się przyjemniejsza. Trwałość tworzywa plus wykorzystanie silnego aluminiowego okucia to gwarancja zadowolenia klientów.

Drewniany trzonek gwarantuje stabilność, jednocześnie jest przyjazny dla środowiska.

Rich colour availability and fresh design make winter more cozy. Durability of the material together with the massive aluminium blade guarantee customers' satisfaction.

Wooden shaft guarantees stability and is eco-friendly at the same time.



Classic 40 Wood

Kolory: 

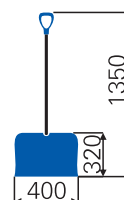

 2070

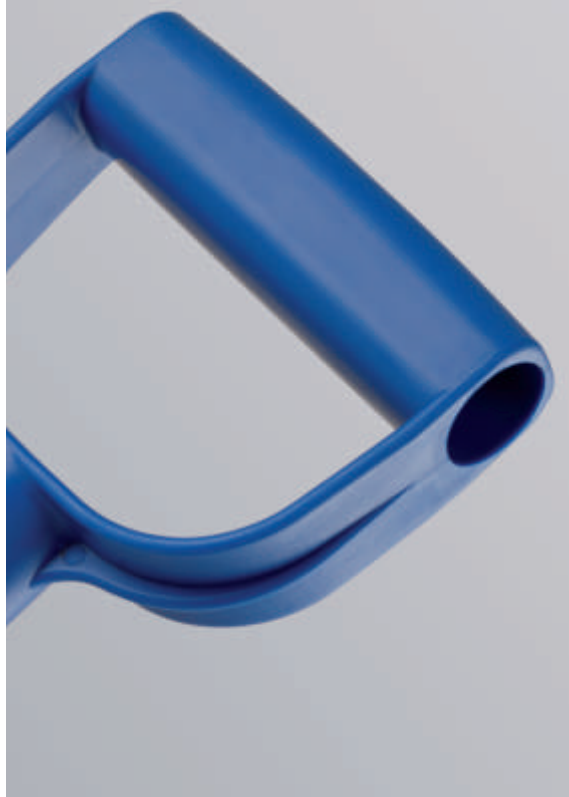

Classic 46 Wood

Kolory: ● ● ● ● ●

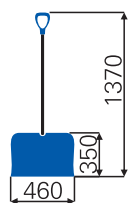

N° 2080



Classic 55 Wood

Kolory: ● ● ● ● ●

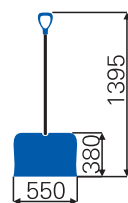

N° 2090





Classic Composite



Dostępne w bogatej kolorystyce i nowoczesnym designie sprawiają, że zima jest bardziej przyjazna. Trwałość tworzywa plus wykorzystanie metalowego okucia to gwarancja zadowolenia klientów. Ten trzonek to połączenie funkcjonalności, nowoczesności i lekkości.

Rich colour availability and fresh design make winter more cozy. Durability of the material together with the steel blade guarantee customers' satisfaction. Composite shaft – combination of functionality, novelty and lightness.

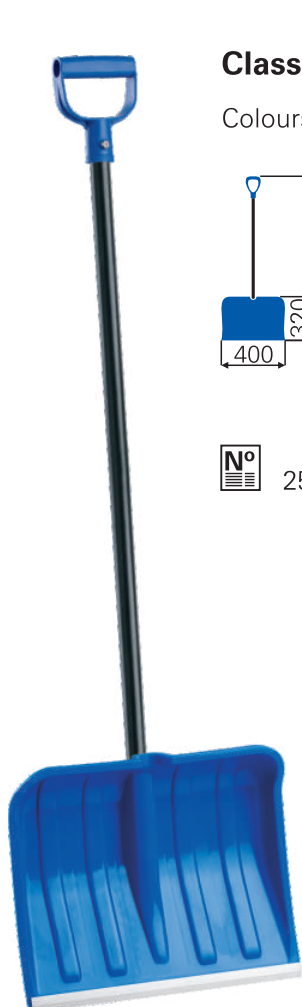

Classic Composite 40

Colours: ● ● ● ● ●

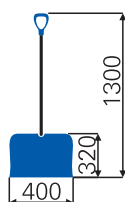

N° 2530



Classic Composite 46

Colours: ● ● ● ● ●

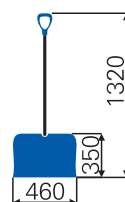

N° 2540

Alu Ergo



Wyprodukowana z oryginalnego surowca gwarantującego wytrzymałość w najtrudniejszych warunkach atmosferycznych. Praktyczny, ergonomiczny trzonek dla wymagających klientów.

Made from the original material which guarantees durability in the most harsh weather conditions and in very low temperature. Practical ergo aluminium shaft it is handy bonus for such a great buy.

Alu Ergo 46

Colours: ●

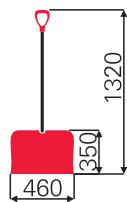

N^o 2560



Alu Ergo 55

Colours: ●

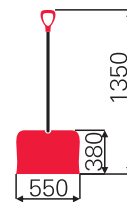

N^o 2550





Power Max



Najbardziej wytrzymała łopata dla wymagających klientów, stawiających wyżej jakość od ceny. Wykonana z oryginalnego surowca, gwarantującego wytrzymałość w najtrudniejszych warunkach atmosferycznych. Metalowy sztyl gwarantuje długie życie łopaty.

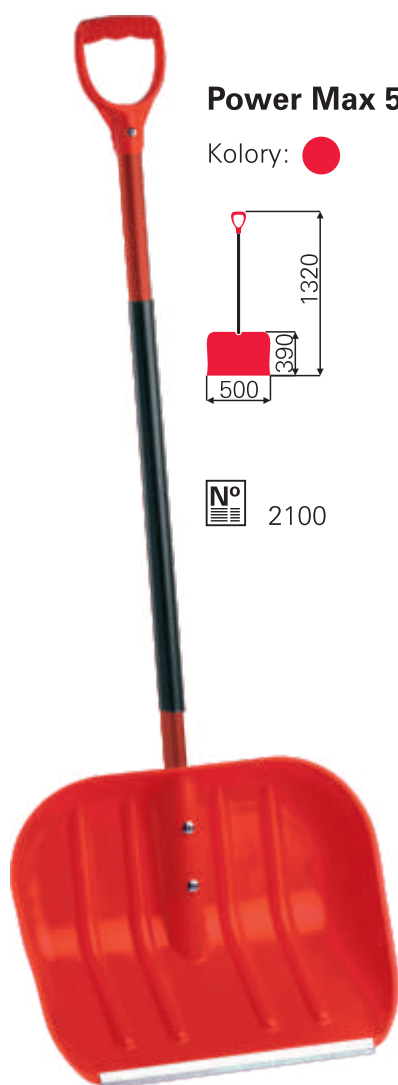

Power Max 50 Steel

Kolory: ●

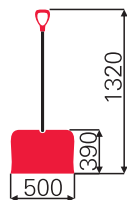

Nº 2100



Power Max 55 Steel

Kolory: ●

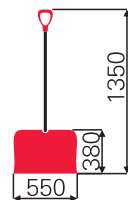

Nº 2110

Ergo Power Max



It is the most durable option for the most demanding customers who put quality before price. Made from the original material which guarantees durability in the most harsh weather conditions and in very low temperature. Metal finishing guarantees long life of the shovel.

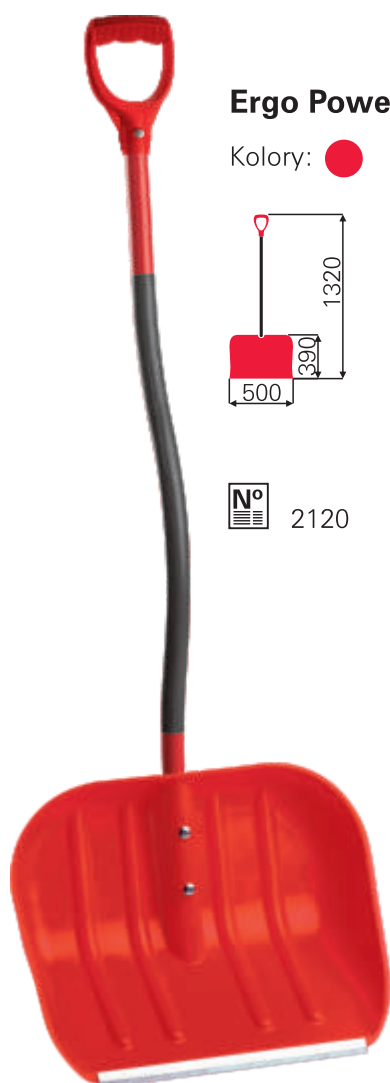

Ergo Power Max 50 Steel

Kolory: ●

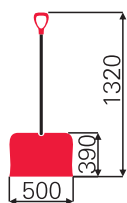

N° 2120

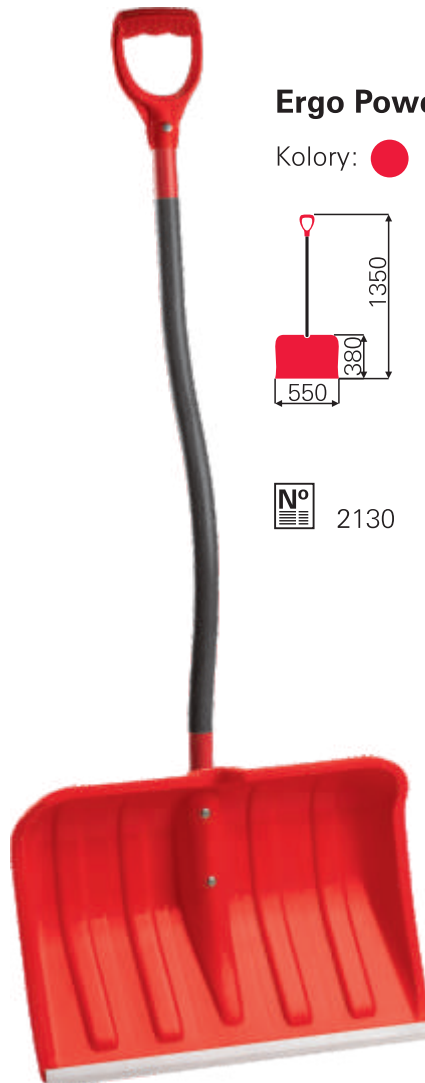

Ergo Power Max 55 Steel

Kolory: ●

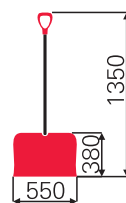

N° 2130



Euro Black



Przyjazne dla środowiska – dostępne w trzech uniwersalnych rozmiarach. Nowoczesna technologia odzysku surowców wtórnych, poprzez ich modyfikację, gwarantuje wysoką jakość produktu za przystępną cenę.

Aluminiowy trzonek to połączenie funkcjonalności, nowoczesności i lekkości.

Eco-friendly shovels available in three universal sizes. Produced with the most modern recycling technologies which help modify the raw material to the quality that is still acceptable with the competitive price.

Aluminium shaft – combination of functionality, novelty and lightness.



Euro Black 40 Alu

Kolory: ●



 2140



opcjonalnie składanie topaty na klips
telescopic shaft option

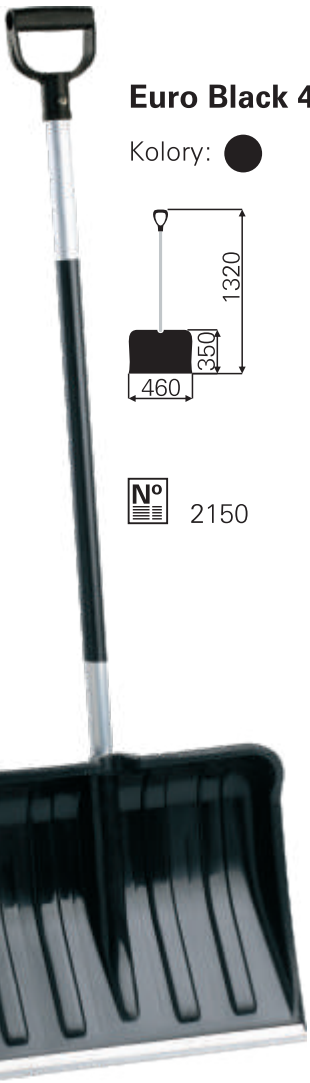

Euro Black 46 Alu

Kolory: ●

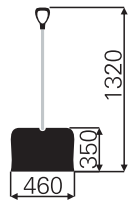

N° 2150

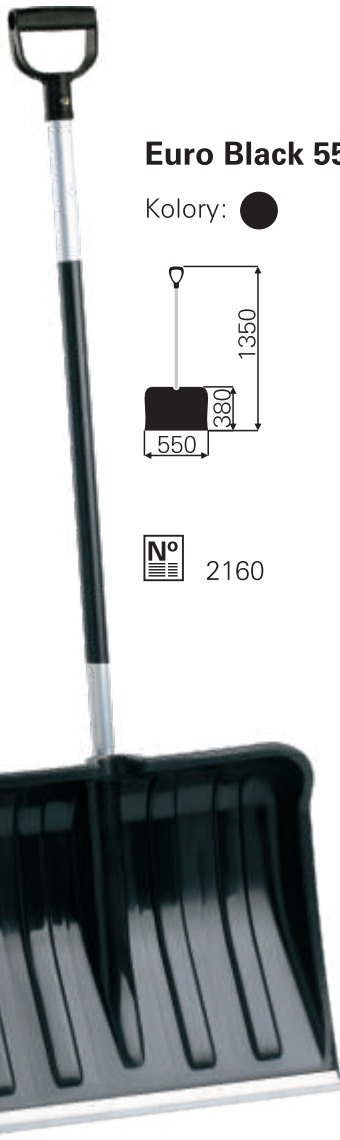

Euro Black 55 Alu

Kolory: ●

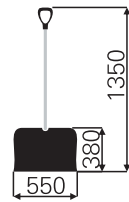

N° 2160



Euro Black



Przyjazne dla środowiska – dostępne w trzech uniwersalnych rozmiarach. Nowoczesna technologia odzysku surowców wtórnych, poprzez ich modyfikację, gwarantuje wysoką jakość produktu za przystępną cenę.

Drewniany trzonek gwarantuje stabilność, jednocześnie jest przyjazny dla środowiska.

Eco-friendly shovels available in three universal sizes. Produced with the most modern recycling technologies which help modify the raw material to the quality that is still acceptable with the competitive price.

Wooden shaft guarantees stability and is eco-friendly at the same time.

Euro Black 40 Wood

Kolory: ●



N° 2170

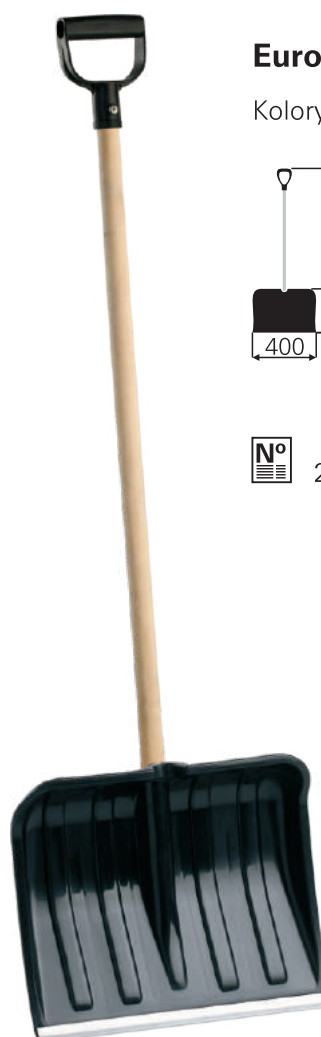



Euro Black 46 Wood

Kolory: ●

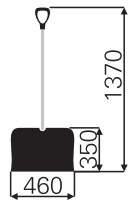

 2180



Euro Black 55 Wood

Kolory: ●



 2190





Eco Composite



Przyjazne dla środowiska, dostępne w dwóch rozmiarach z super lekkim i wytrzymałym trzonkiem. Nowoczesna technologia odzysku surowców wtórnych, poprzez ich modyfikację, gwarantuje wysoką jakość produktu za przystępną cenę.

Eco-friendly shovels available in two sizes with super light and strong composite shaft. Produced with the most modern recycling technologies which help modify the raw material to the quality that is still acceptable with the competitive price.





Girl Thing



Specjalna opcja dla kobiet na całym świecie. Świetny design, lekkość i funkcjonalność zawierają się w tych dwóch słowach: Girl Thing. Czy istnieje lepsza kombinacja dla kobiet? Zapracowane, a jednocześnie dbające o oprawę estetyczną kobiety docenią produkt dedykowany specjalnie dla nich. Łopaty są idealnie dopracowane i wyważone. Na pewno staną się obiektem pożądania każdej kobiety.

Special option for women around the world. Great design, lightness and functionality boil down to these two words: Girl Thing. Could there be any better combination for women? Busy yet caring about the esthetic side, women will surely appreciate the product specially dedicated for them. The shovels are perfectly refined and balanced. They will obviously become the object of every woman's irresistible desire.



Girl Thing Alu

Kolory: ● ● ● ● ● ●

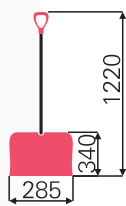

N° 2220

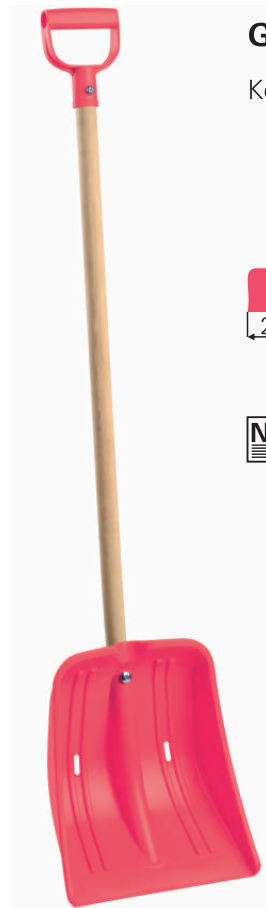

Girl Thing Wood

Kolory: ● ● ● ● ● ●

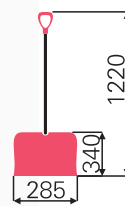

N° 2230



Pusher Classic



Seria Pusher to bardzo wytrzymałe a przy tym poręczne zgarniacze do śniegu. Zamontowany układ jezdny jest optymalnym rozwiązaniem do przemieszczania śniegu.

Pushers are very strong and handy tools. Fitted drive system is a good idea for snow removal.

Classic 1

Kolory: 



Classic 2

Kolory: 





Pusher Black



Pusher Black jest to narzędzie, z którym wkład wysiłku w odśnieżanie chodników i podjazdów będzie mniejszy.

Pusher Black it is a tool which minimizes the amount of effort you need to put in to cleaning your sidewalks and driveways.

Black 1

Kolory: ●

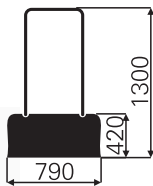

N° 2363

Black 2

Kolory: ●

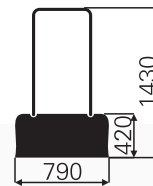

N° 2364



Black 1 Eco

Kolory: ●

N° 2365



Pusher Shark



Pusher Shark 1 to nowoczesne i funkcjonalne urządzenie do odśnieżania. Ukośna linia produktu powoduje, że śnieg jest usuwany na bok bez dodatkowego wysiłku, wystarczy pchać je do przodu. Jest to idealny zgarniacz do odśnieżania chodników, podjazdów i ścieżek przydomowych. Nasz nieskomplikowany skośny zgarniacz działa niemal jak odśnieżarka mechaniczna.

Pusher Shark 1 is an advanced and functional tool for snow removal. The sidelong shape allows to remove snow with no additional effort, just pushing the product ahead. It is an ideal snow remover shovel for clearing pavements, driveways and paths. Our not complicated sidelong pusher just gives the effect of an mechanical snow blower.



Shark 1

Kolory: ● ●

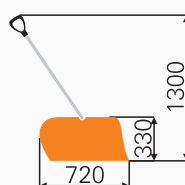

N° 2410

Shark 1 Eco



Kolory: ●

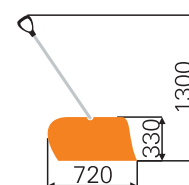

N° 2411



Nord



Praktyczna, głęboka łopata, która służy nie tylko do odgarniania śniegu, znakomicie sprawdza się również jako łopata do zboża. Opcja eco – dzięki zastosowaniu nowoczesnej technologii odzysku surowców wtórnych, gwarantuje wysoką jakość produktu za przystępną cenę.

Practical, deep shovel, that can be used not only for snow removal but it is also a great tool for grain.

Eco option – thanks to the most modern recycling technologies, eco-friendly shovels guarantee good quality for competitive price.

Nord Alu

Kolory: ● ● ●

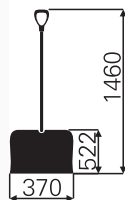

N° 2372

Nord Alu Eco



N° 2370



Nord Wood

Kolory: ● ● ●

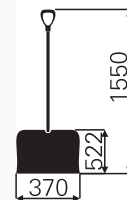

N° 2373

Nord Wood Eco



N° 2371





Alu



Łopaty aluminiowe - opcja dla osób, które wysoko cenią sobie wytrzymałość i precyzję wykonania. Masywne, jednocześnie lekkie sprawdzają się w nawet najbardziej ekstremalnych warunkach atmosferycznych.

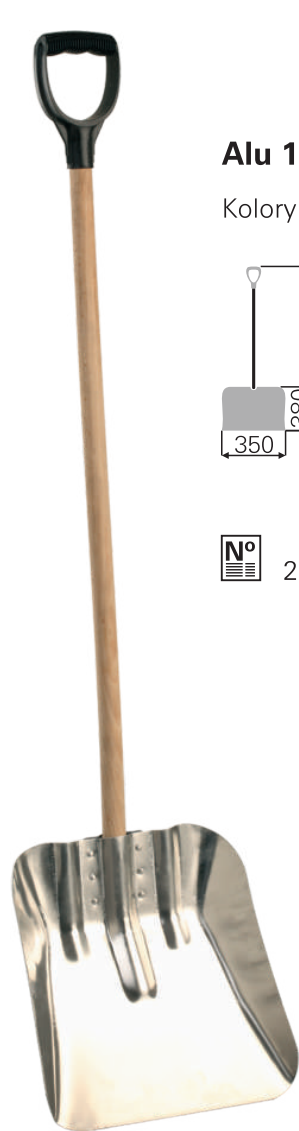

Alu 1

Kolory: ●

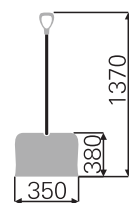

N° 2290

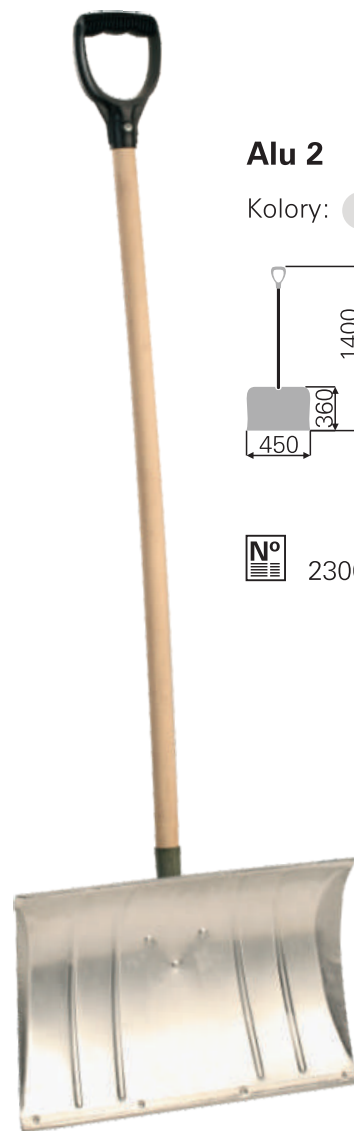

Alu 2

Kolory: ●

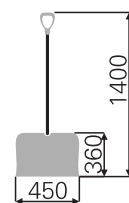

N° 2300

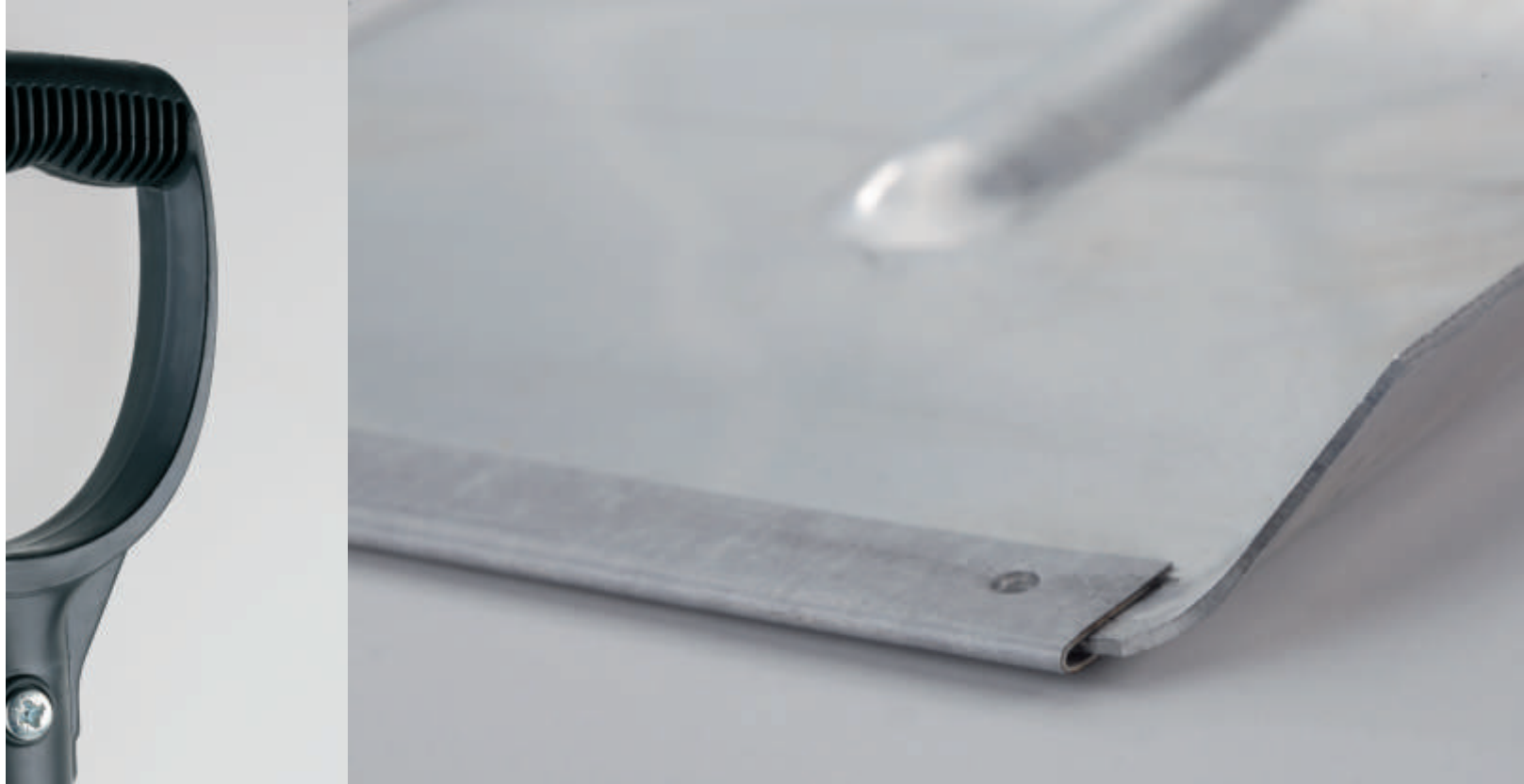

Aluminium shovels - option for people who highly appreciate durability and precision. Massive yet light, aluminium shovels find their use in even the most extreme weather conditions

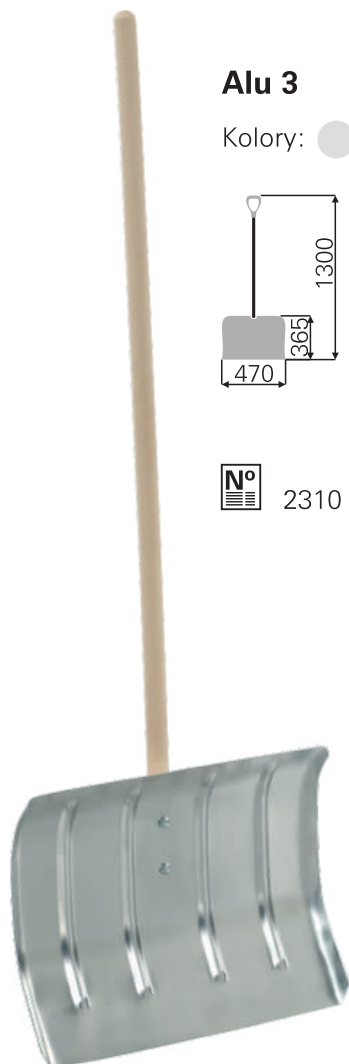



Alu



Lekkie i uniwersalne łopaty aluminiowe, sprawdzają się w ekstremalnych warunkach atmosferycznych.

Light and universal aluminium snow shovels, find their use even in extreme weather conditions.





Ice Crusher



Ice Crusher świetnie sprawdza się w walce z lodem i grudkami przymarznętego błota. Jest lekki i funkcjonalny. Dostępny w trzech rozmiarach.

Ice Crusher has been designed to fight against ice and frozen mud lumps on the pavement. It is light and functional. Available in three sizes.

Ice Crusher 1

Kolory: ●

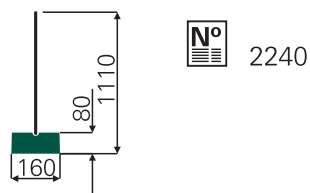

Ice Crusher 2

Kolory: ●

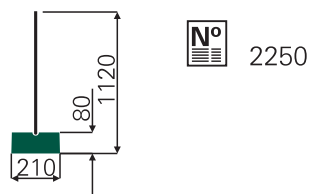

Ice Crusher 3

Kolory: ●

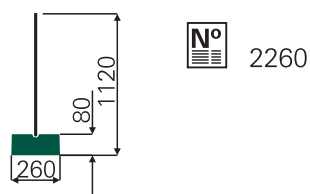



Auto Sapper Click



Ta teleskopowa łopata ma za zadanie sprawdzić się w warunkach, gdzie czynnikiem decydującym jest mała ilość miejsca. Łopata złożona zajmuje tyle miejsca co kosmetyczka kobieca, a posiadanie jej w aucie jest porównywalnie ważne. Po rozłożeniu, łopata niczym nie ustępuje opcji pełnowymiarowej. Jest mocna i stabilna. Opływowy kształt czyni ją ergonomiczną. Satisfakcja gwarantowana.

This telescopic shovel is to be used in space shortage conditions. Shovels - when assembled - is of the size of women's purse whereas having it in the car is probably nearly as important. After composing the shaft, the shovel is as functional as the standard type. It is stable and strong. The streamline shape makes the shovel ergonomic. Satisfaction guaranteed!



Auto Sapper Click

Kolory: ●

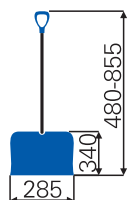

N^o 2200

opcja
optional bag



N^o 2201



Trapper Sapper



Łopata trapper sapper, której zadaniem jest pomoc miłośnikom górskiej wspinaczki w dotarciu na sam szczyt. Jej opływowy kształt i wygodny uchwyt są świetnym rozwiązaniem dla turystów. Łopata jest lekka i funkcjonalna. Bon voyage!

Trapper sapper shovels whose main function is to help mountaineering enthusiasts to get straight to the top. Its streamline and handy shaft are a great solution for the tourists. The shovel is light and functional. Bon voyage!



Trapper Sapper Click

Kolory: ●

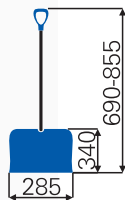

N^o 2210



Trapper Sapper Wood

Kolory: ●

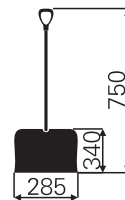

N^o 2211



Kid Pro 1



Łopaty dedykowane dla dzieci.
 Dostępne w pięciu nowoczesnych kolorach, które dzieci zdecydowanie polubią. Łopaty są bezpieczne dzięki swojemu starannemu wykończeniu. Cechuje je lekkość i fantazja.
 Opcja: Baw się i pracuj – wykorzystanie łopat dla dzieci może także okazać się strzałem w dziesiątkę dla zapracowanych rodziców.

Shovels dedicated for the kids.
 Available in five modern colours which the kids will obviously get to like. The shovels, thanks to their precise finishing, are safe for kids. They are light and fanciful. Work and have fun! – Shovels for kids is a good solution for busy parents.

Kid Pro 1

Kolory: ● ● ● ●

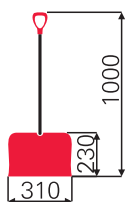

 2270



Kid Pro 2



Bezpieczeństwo produktu zagwarantowane jest dzięki starannemu wykończeniu. Ta dbałość o szczegóły i dostępność bajecznych kolorów pozwoliły nam na stworzenie świetnego produktu, który będzie chciało mieć każde dziecko.

The products' safety is guaranteed thanks to their thorough finishing. It is the care for details and rich colour availability that have enabled us to create this great product which the kids will be eager to have.



Kid Pro 2 Alu

Kolory:

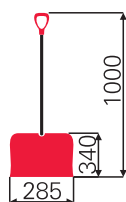

N° 2280



Kid Pro 2 Wood

Kolory:

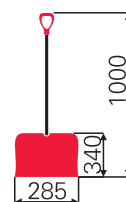

N° 2284

Comfort Line



Dla dzieci powyżej 4 roku życia.
Suitable for children over 4 years.

Comfort Line M

Kolory: ● ● ● ● ●

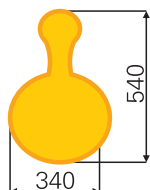

N^o 2344

Comfort Line XL

Kolory: ● ● ● ● ●

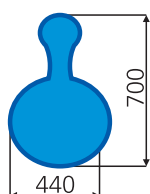

N^o 2345



Dla dzieci powyżej 6 roku życia.
Suitable for children over 6 years.

S-Kid



S-Kid 1

Kolory: ● ● ● ●

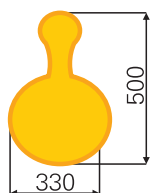

N^o 2350

S-Kid 2

Kolory: ● ● ● ●

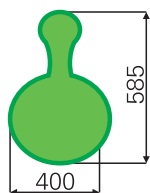

N^o 2360

S-Kid 3

Kolory: ● ● ● ●



N^o 2340





Speedy



Sanki Speedy są lekkie a jednocześnie wytrzymałe. Precyzja wykonania zapewnia bezpieczeństwo i długie życie produktu. Sanki dostępne także w wersji z hamulcami. A to wszystko dla dzieci, które kochają zabawy na śniegu!

Sleigh "Speedy" is light but strong. Precision which is characteristic of this item ensures safety and long life of the product. Sleighs are also available with brakes. Everything for the kids who love playing in snow scenery!



Speedy 1

Kolory: ● ● ● ● ●

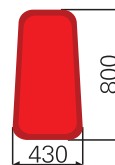

N^o 2330



Speedy 2

Kolory: ● ● ● ● ●

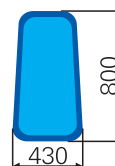

N^o 2320



Speedy 3

Kolory: ● ● ● ● ●

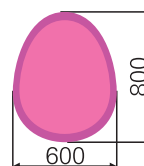

N^o 2325



Sanki | Sleigh



Speed Bob

Kolory:     

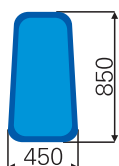

N^o 2343



Sanki z nowatorskim rozwiązaniem mocowania linki z rączką. Wyposażone są w metalowe, nierdzewne plozy.

Sled with an innovative solution to the handle attachment links. They are equipped with stainless steel metal runners.

Star Reliance

Kolory:     

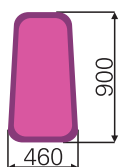

N^o 2341



Star

Kolory:     

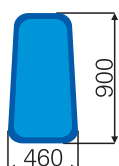

N^o 2342



Hand



Cztery rodzaje uchwytów dla łatwiejszej pracy.

Four different types of shovel grips, to make you work easier.

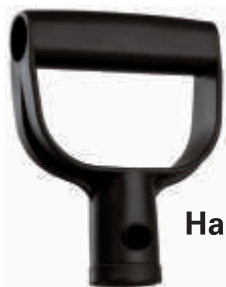

Hand 1

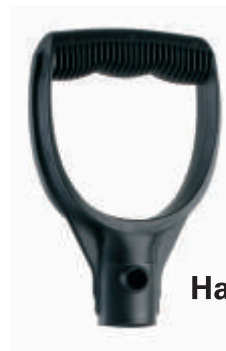

Hand 2



Hand 3

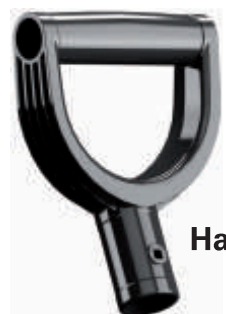

Hand 4



Displays

Dla jeszcze lepszej ekspozycji i porządku.

To have more space and better exposure.



Option 1

Option 2

Option 3



FORM-PLASTIC Sp. z o.o.

Polska, 87-720 Ciechocinek, ul. Bema 146

tel.: +48 54 283 62 63

www.snowshovels.eu

biuro@formplastic.pl

fax: +48 54 283 22 77

www.formplastic.pl

office@formplastic.pl

